



MBMF

An ideal solution for projects that need punch,
for 70 to 250 feet.



“UNIQUE LIGHTING SOLUTIONS”

ORDERING

MBMF-(watt)	(watt) = specified Wattage
-MH	150W-250W Metal Halide Lamp
-HPS	70W-250W High Pressure Sodium Lamp
-CRI	Color Rendering Index*
-CCT	Correlated Color Temperature*
-CWA	Core and Coil Ballast
-RLEG	Regulated Lag Ballast
-ELEC	Electronic Ballast
-GR	Glass Reflector †
-CB	Cast Metal Mounting Bracket
-SS	Stainless Steel Housing
-TF	Cast Metal Tenon Fitter
-CF	Custom Finish*
-XXX	Ballast Voltage*
-AGS	Anti Glare Shield (internal)
-CL	Colored Lens*
-SL2	Spread Lens (12°)
-SL3	Spread Lens (30°)
-SPG	Special Glass Pattern*
-FLP	Facade Lighting Package
-SNXX	Snoot in inches (note internal color)*
-RBB	Remote Ballast Box

* Consult Factory
† See MBMF-GR for photomet-

DIMENSIONS

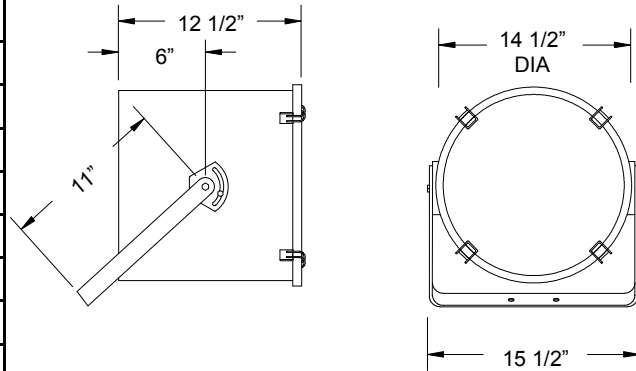

PHOTOMETRICS

SETBACK DISTANCE (FEET)	Fc AT CENTER	FIELD DIA (FEET)
50	427.6	10.9
100	106.9	21.7
150	47.5	32.6
200	26.7	43.5
250	17.1	54.3
300	11.9	65.2

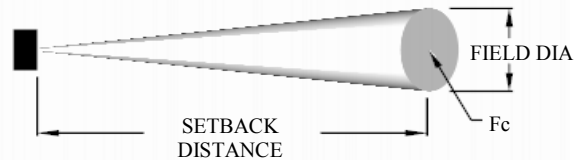

EXAMPLE: MBMF-150-MH-95-4000-CWA-CB-120-SL1-SN24

SPECIFICATIONS

Housing— Galvaneal steel with an aluminum lens frame for complete seal against moisture. Housing can also be specified as Stainless Steel.

Lamps— 70W to 250W HID. Please contact factory for lamp selections not found on ordering selector.

Lens— Clear tempered glass lens. 12, and 30 degree spread lens are optional, as well as frosted, patterned, or colored.

Reflector— High reflectance, spun aluminum for maximum control of beam. As an option, can be fitted with a mirrored, glass reflector for even more precise applications.

Finish— High quality, outdoor, polyester, powder coat.

Ballast— Integral, core and coil ballast. Remote core and coil and electronic ballasts are also available.

Mounting— The mounting is a rigid, formed metal yoke. Provided with an adjustment plate on each side for easy positioning.

Weight— Approximately 33 lbs (with no options).

Labels— NRTL Listed for wet locations.



MBMF

An ideal solution for projects that need punch,
for 70 to 250 feet.



“UNIQUE LIGHTING SOLUTIONS”

FILE INFORMATION

Photometric Filename: LLI090412B.IES

Descriptive Information (From Photometric File)

IESNA:LM-63-2002
 [TEST] LLI 0904-12B
 [TESTLAB] LIGHT LABORATORY INC
 [ISSUEDATE] 9/30/2004
 [MANUFAC] ARC LIGHTING SYSTEMS.
 [LUMCAT] MBMF-150-MH-95-4000-CWA-120
 [LUMINAIRE] 14-3/8" DIA. X 12-1/4" SEARCH LIGHT.
 [MORE] SEMI-SPECULAR REFLECTOR.
 [MORE] TEMPERED FLAT GLASS LENS.
 [BALLASTCAT] ADVANCE M102 71A54A3
 [BALLAST] 120 60Hz MAGNETIC.
 [LAMPPOSITION] 0.90
 [LAMPCAT] PHILIPS CDM150/T6/830
 [LAMPLUM] 13500
 [WATT] 180.6

CHARACTERISTICS

IES NEMA Type	1 H x 1 V
Maximum Candela	1069094
Maximum Candela Angle	0 H 0 V
Horizontal Beam Angle (50%)	4.7
Vertical Beam Angle (50%)	4.7
Horizontal Field Angle (10%)	12.4
Vertical Field Angle (10%)	12.4
Total Rated Lamp Lumens	13500
Beam Lumens	3939.97
Beam Efficiency	29.18%
Field Lumens	10483.23
Field Efficiency	77.65%
Spill Lumens	3088.79
Total Lumens	13572.02
Total Efficiency	100.53%

LUMEN MULTIPLIERS

WATT	TYPE	MULT
150	CMH	1.00
150	MH	0.50
250	MH	1.00
70	HPS	0.23

WATT	TYPE	MULT
100	HPS	0.42
150	HPS	0.73
200	HPS	1.04
250	HPS	1.31

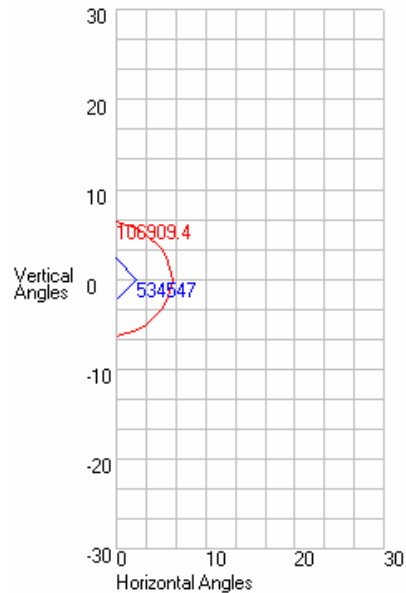
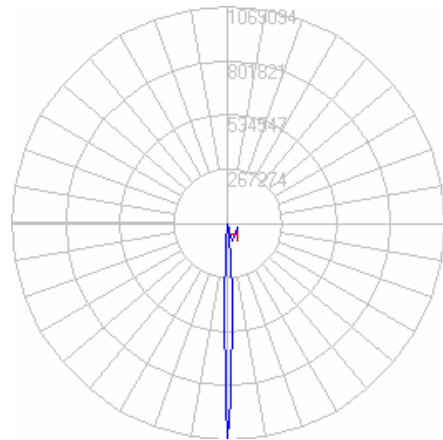
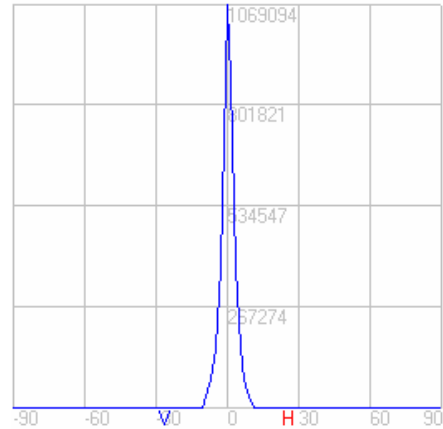



MBMF

An ideal solution for projects that need punch,
for 70 to 250 feet.



“UNIQUE LIGHTING SOLUTIONS”

APPLICATIONS

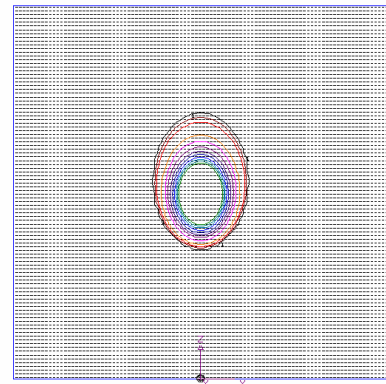
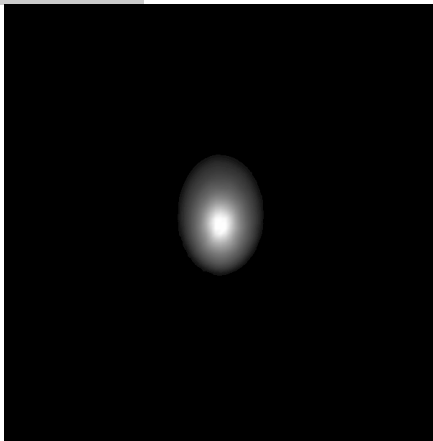

25 FEET FROM SURFACE, 45 DEGREE TILT

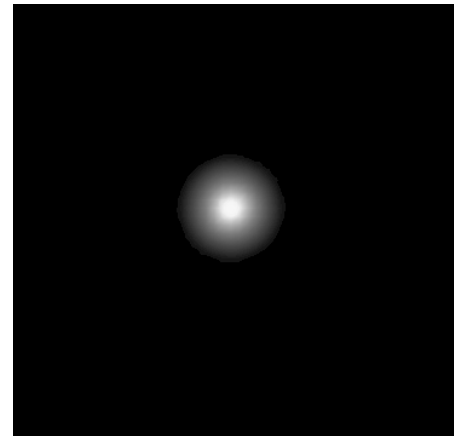
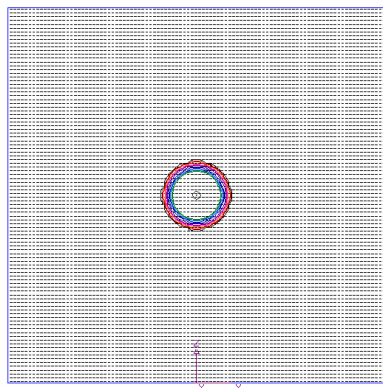

25 FEET FROM SURFACE, 90 DEGREE TILT

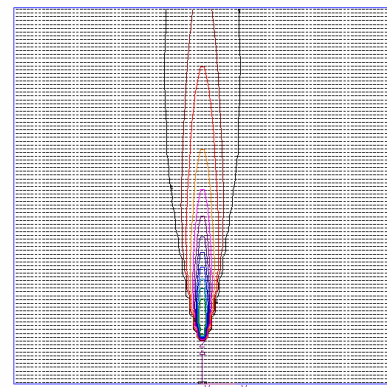
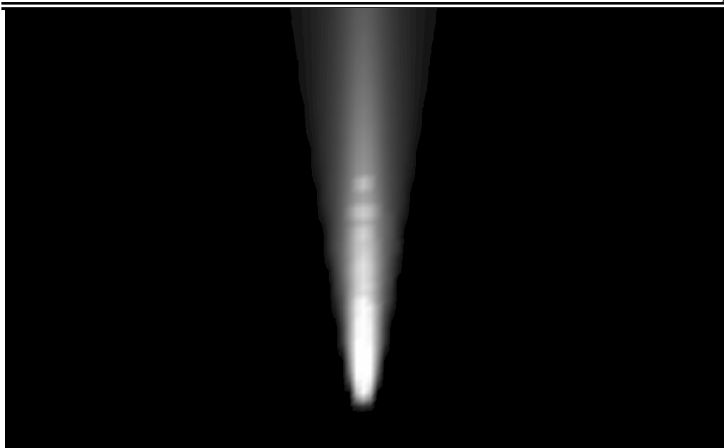

1 FOOT FROM SURFACE, 180 DEGREE TILT